



Audio Pro 1

Robin Pro SIP Audio Intercom



- Clear communication through HD Audio
- 1x touch-sensitive call button
- High-end full anodised aluminium
- Weatherproof & UV-resistant
- Power-over-Ethernet (PoE)
- Built-in relay

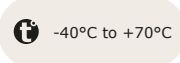
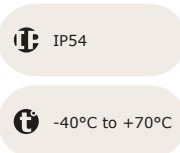

Product Description

The Robin Pro SIP Audio Intercom is a professional IP-based audio intercom designed for reliable and intuitive communication. With a simple press of the doorbell, the system generates a clear call signal and instantly connects to a configured telephone, SIP client, or device.

The intercom supports Secure SIP protocol, enabling straightforward integration with a wide range of SIP-based telephone systems. Suitable for both residential and commercial applications, it offers dependable performance in demanding environments.

For enhanced usability, the Robin Pro features engravable, LED-backlit push-buttons, ensuring excellent visibility and clear identification even in low-light conditions.

High-definition audio performance is delivered through advanced codecs, providing crystal-clear voice quality for accurate and natural communication.

Also Available in This Range



Audio Pro 1
F0413000002
Robin 1-Button Pro SIP Audio Intercom



Audio Pro 2
F0413000003
Robin 2-Button Pro SIP Audio Intercom



Audio Pro 4
F0413000004
Robin 4-Button Pro SIP Audio Intercom



Audio Pro Keypad
F0413000005
Robin Digital Keypad Pro SIP Audio Intercom

All the information contained within this document (pictures, drawings, features, dimensions, specifications), could be perceptibly different and can be changed without prior notice. 29/01/26 CDVI_Audio Pro 1_DS_01_EN-FR_A4_C



Technical Specifications

Mechanical

Material	Anodised aluminium (brushed finish) with engravable tag
Humidity	5-95% non-condensing (RH)
Weight	866g
IP Rating	IP54
Dimensions	257 x 110 x 42 mm

Interface

LAN	10/100BASE-TX with push-in terminal block at intercom-side
Cable Type	Cat5e or above
Passive Switch	NO/NC-contact, up to 24V / 0.75A (18W)

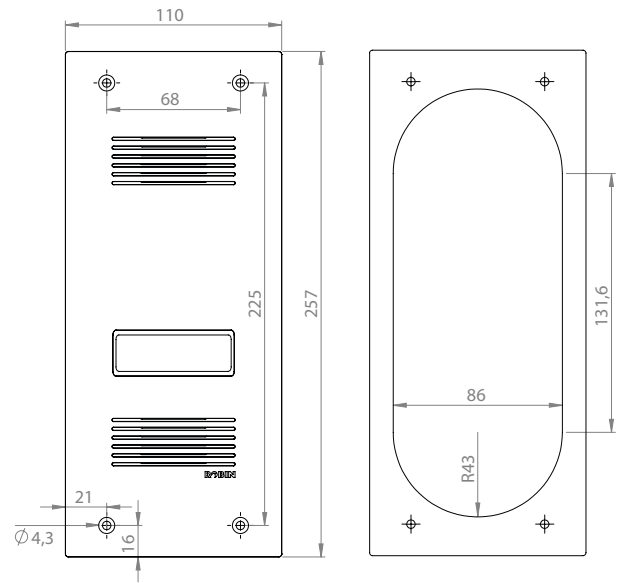

Signaling Protocols

SIP	UDP, TCP, TLS
Secure SIP	Yes
Integrations	API

Mobile Applications

Android & iOS	Native PBX, Microsoft Teams
Web Interface	HTTP, HTTPS
SSL Certificate	Yes
CSR	Yes

Firmware

Checking	Automatic
Installation	Manual (automatic with rollback)
Support	Remote access, VPN-tunnel

Accessories



Pro SB

Robin Pro surface mounting box



Pro FB

Robin Pro in-wall mounting box

Proline Label 1V

Replacement label for Audio Pro 1

Webrelay

IP-Quad Webrelay (PoE)

Audio

Codecs	uLaw, aLaw, G.722, OPUS
Protocol	RTP/SRTP
Microphone	Omni-directional
Sensitivity	-44 ±3 dB (1 kHz, 0 dB = 1 V/Pa)
SNR	~70dB
Speaker	Integrated
Frequency	180-17000Hz
Output	2 WRMS
SPL	84dB (1W/1m)
Resonance Frequency	300 Hz

Electrical

Power Supply	PoE IEEE802.3af - 15.4W
---------------------	-------------------------